



Emergency Egress and Exit Signs

Photoluminescent Products to support the Fire Code of the Philippines

- Egress Products
- Exit Signs
- Emergency Evacuation Plans
- Fire Safety Signs



Completed Projects Using Ecoglo Products



1. Supreme Court, Singapore
2. US Bank Tower, Los Angeles
3. Burj Khalifa, Dubai
4. Venetian Macao, Macau
5. Eaton Centre, Toronto
6. Yuen Long MTR Station, Hong Kong
7. MCG, Melbourne

ecoglo[®]
VISIBLY BETTER

Ecoglo in the Philippines

Ecoglo International Ltd (EIL), a New Zealand-based manufacturer, has been producing and shipping its range of photoluminescent egress and fire safety products from Christchurch for over 25 years, with over 50% of sales directed to the USA. Since 2019, EIL has focussed on the Philippines, working to establish a strong brand presence in the market.

Ecoglo Fire Protection Product Trading (EFPPT) has served as EIL's contracted marketing representative in the Philippines since 2019, functioning as both a reseller and installer.

This collaboration has led to EIL products being installed in a number of high-profile projects, including:

- Philippine Sports Commission - Rizal Memorial Stadium Admin Building
- Public Safety Mutual Benefit Fund Inc.
- Gotesco Regency Twin Towers
- De La Salle Laguna Campus
- Government Service Insurance System
- The Lind Hotels
- Amazon PHL
- Calapan Port (PPA)
- Cebu Port Authority
- University of Santo Tomas
- Scheduled installations in all 12 buildings of the House of Representatives (March/April 2025)

As EIL's presence in the Philippines evolves, EFPPT will transition to focus on high level marketing and technical support for our resellers and installers. EFPPT will continue to manufacture and supply custom printed Emergency Evacuation Plans and carry out added value fabrication for end-user customers and resellers.

To ensure continuity and quality of customer service, EFPPT will act as the reseller and installer of last resort if resellers are unable to service a project. EIL plans to hold consignment inventory with its 3PL logistics partner for efficient and timely distribution to resellers and installers.

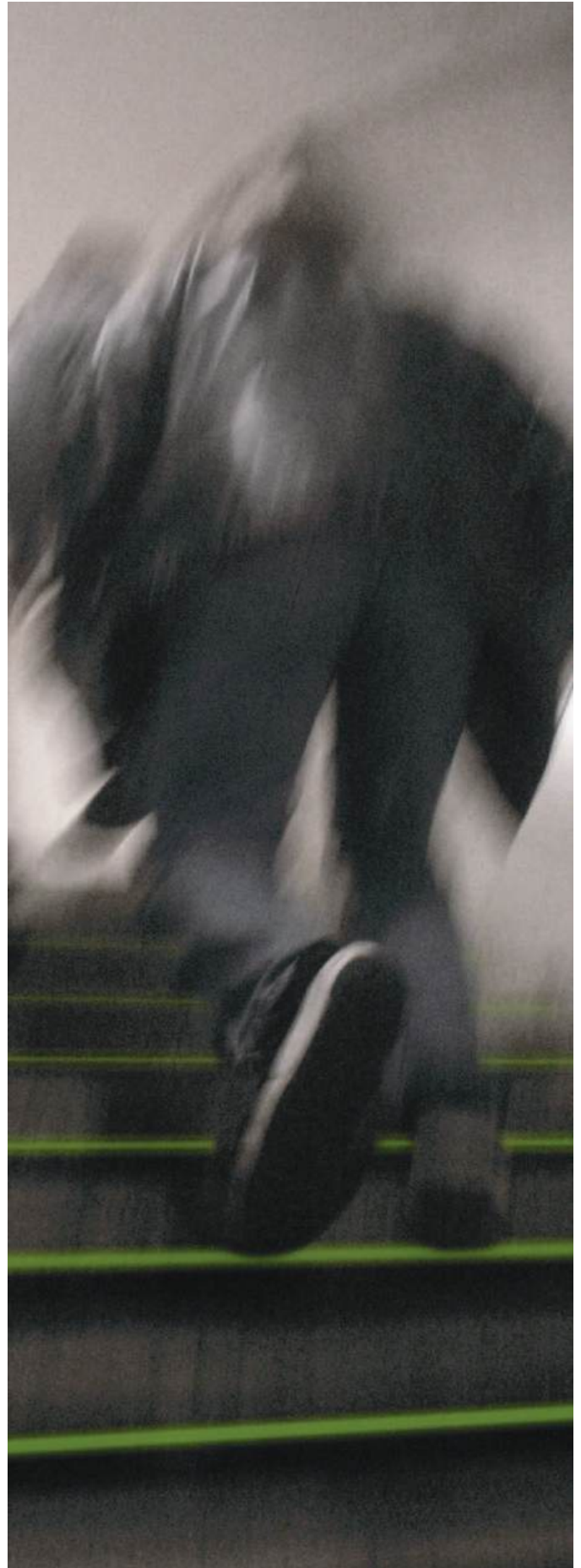



Egress Products

Step Products PL and Anti-slip

F9-175 Step Nosing 50mm x 25mm

Available in standard lengths from 800mm to 1500mm in 100mm increments

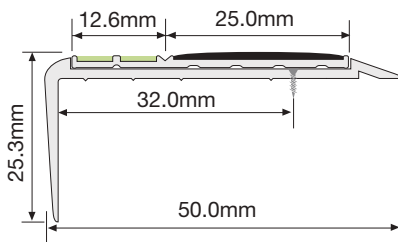
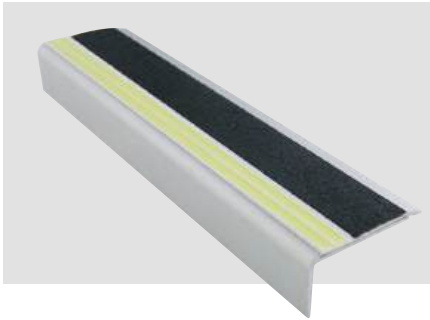

- Supplied pre-drilled with fixers.
- Adhesive and caulking gun available separately
- Custom cutting is available from 2450mm and 3060mm lengths

F14-175 Step Nosing 75mm x 10mm

Available in standard lengths from 800mm to 1500mm in 100mm increments

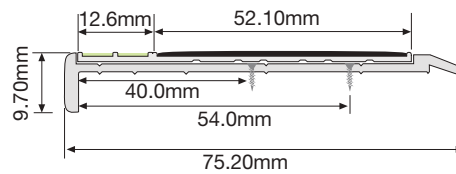
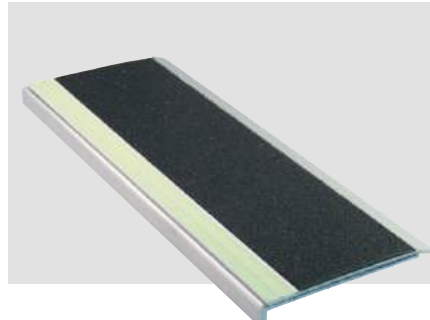

- Supplied pre-drilled with fixers.
- Adhesive and caulking gun available separately
- Custom cutting is available from 2450mm and 3060mm lengths

F15-175 Step Nosing 75mm x 33mm

Available in standard lengths from 800mm to 1500mm in 100mm increments

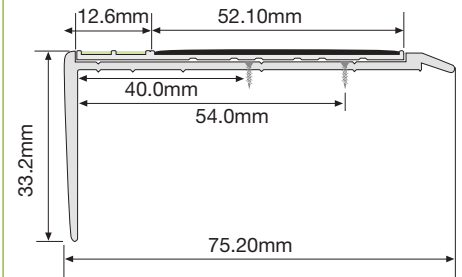
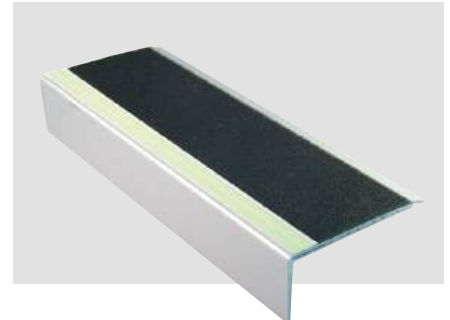

- Supplied pre-drilled with fixers.
- Adhesive and caulking gun available separately
- Custom cutting is available from 2450mm and 3060mm lengths

E22-075 Step Edge Contrast 37.7mm

Available in standard lengths from 800mm to 1500mm in 100mm increments

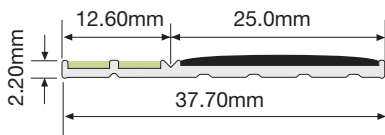
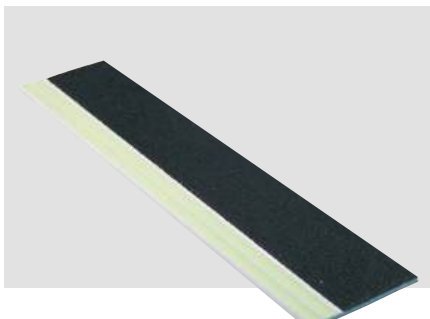

- Adhesive and caulking gun available separately
- Custom cutting is available from 2450mm and 3060mm lengths

E22-075 Polyurethane adhesive fixing
E22-075P Punched for screw fixing

E14-075 Step Edge Contrast 64mm

Available in standard lengths from 800mm to 1500mm in 100mm increments

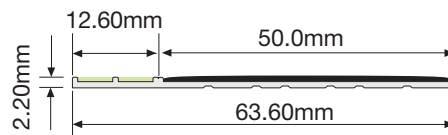

- Adhesive and caulking gun available separately
- Custom cutting is available from 2450mm and 3060mm lengths

E14-075 Polyurethane adhesive fixing
E14-075P Punched for screw fixing

For compliance information see product data sheets (downloadable from website)

Step Products PL and Anti-slip

F9-185 Step Nosing 50mm x 25mm

Available in standard lengths from 800mm to 1500mm in 100mm increments

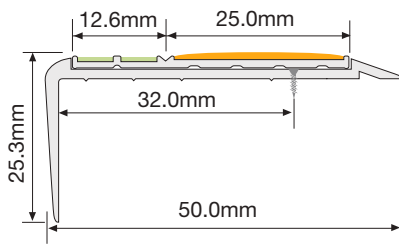
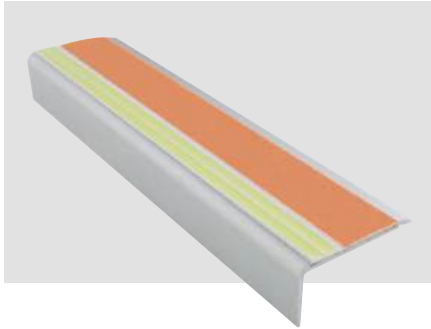

- Supplied pre-drilled with fixers.
- Adhesive and caulking gun available separately
- Custom cutting is available from 2450mm and 3060mm lengths

F14-185 Step Nosing 75mm x 10mm

Available in standard lengths from 800mm to 1500mm in 100mm increments

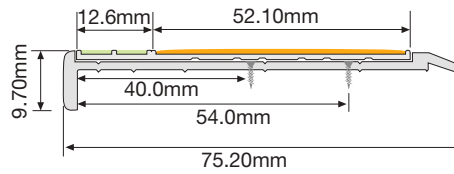
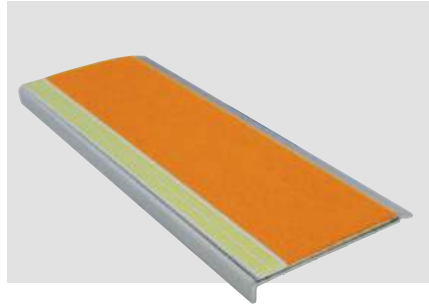

- Supplied pre-drilled with fixers.
- Adhesive and caulking gun available separately
- Custom cutting is available from 2450mm and 3060mm lengths

F15-185 Step Nosing 75mm x 33mm

Available in standard lengths from 800mm to 1500mm in 100mm increments

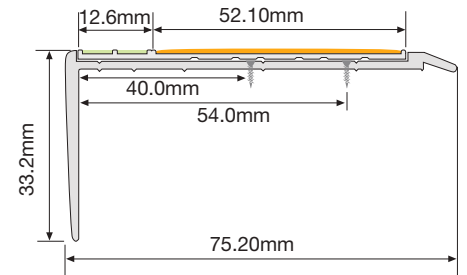
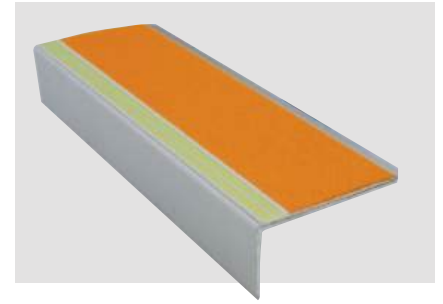

- Supplied pre-drilled with fixers.
- Adhesive and caulking gun available separately
- Custom cutting is available from 2450mm and 3060mm lengths

E22-085 Step Edge Contrast 37.7mm

Available in standard lengths from 800mm to 1500mm in 100mm increments

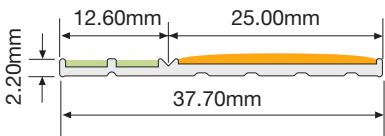
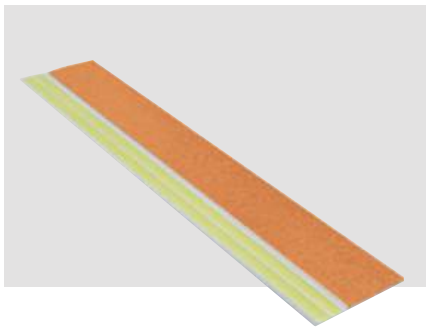

- Adhesive and caulking gun available separately
- Custom cutting is available from 2450mm and 3060mm lengths

E22-085 Polyurethane adhesive fixing
E22-085P Punched for screw fixing

E14-085 Step Edge Contrast 64mm

Available in standard lengths from 800mm to 1500mm in 100mm increments

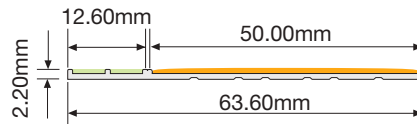
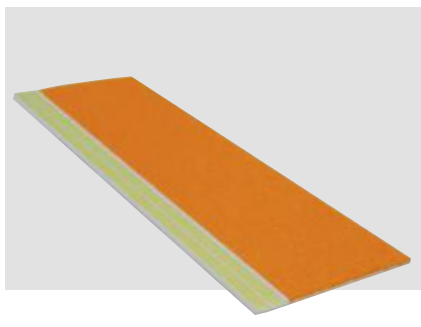

- Adhesive and caulking gun available separately
- Custom cutting is available from 2450mm and 3060mm lengths

E14-055 Polyurethane adhesive fixing
E14-055P Punched for screw fixing

For compliance information see product data sheets (downloadable from website)

Step Products PL and Anti-slip

T2-103 Step Edging 42mm x 3.5mm

Available in standard lengths from 800mm to 1500mm in 100mm increments

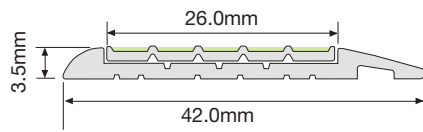
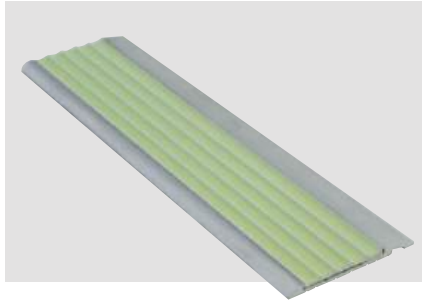

- Supplied pre-drilled with fixers.
- Adhesive and caulking gun available separately
- Custom cutting is available from 3060mm lengths

S5-LM22080 L Marker

Available in a pack containing 10 x left side L Markers and 10 x right side L Markers

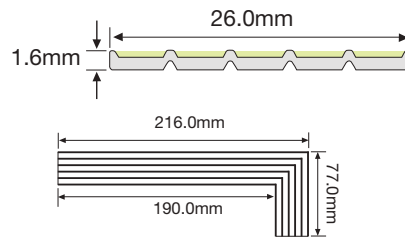
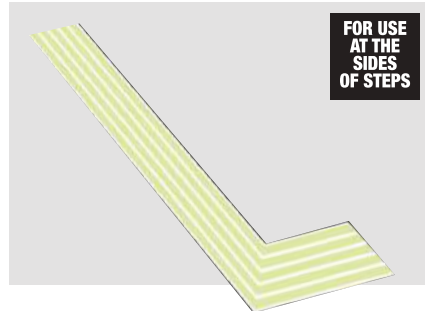

- Supplied as a straight length for folding into shape
- Adhesive and caulking gun sold separately

S5-LM22080 Polyurethane adhesive fixing

Anti-Slip Products

Note: The following products are not Emergency Visibility products as they contain no PL but are suitable for use on step-edges to help prevent slips and falls in all weather conditions.

F9-170 Step Nosing 50mm x 25mm

Available in standard lengths from 800mm to 1500mm in 100mm increments

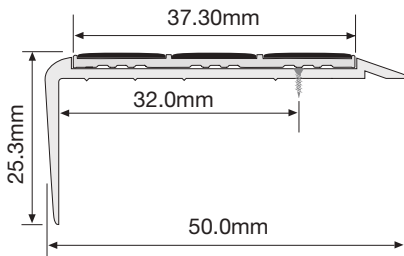

- Supplied pre-drilled with fixers.
- Adhesive and caulking gun available separately
- Custom cutting is available from 2450mm and 3060mm lengths

F14-170 Step Nosing 75mm x 10mm

Available in standard lengths from 800mm to 1500mm in 100mm increments

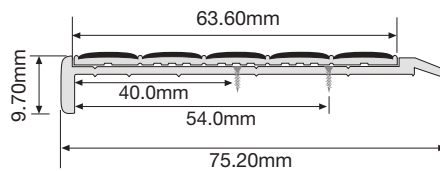

- Supplied pre-drilled with fixers.
- Adhesive and caulking gun available separately
- Custom cutting is available from 2450mm and 3060mm lengths

F15-170 Step Nosing 75mm x 33mm

Available in standard lengths from 800mm to 1500mm in 100mm increments

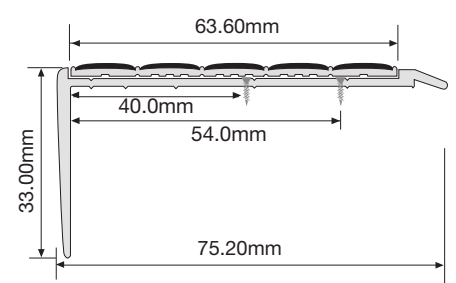

- Supplied pre-drilled with fixers.
- Adhesive and caulking gun available separately
- Custom cutting is available from 2450mm and 3060mm lengths

N2-070 Step Edge Contrast Anti/Slip 37mm

Available in standard lengths from 800mm to 1500mm in 100mm increments

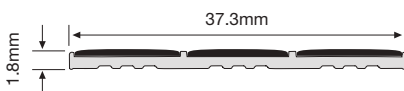

- Adhesive and caulking gun available separately
- Custom cutting is available from 2450mm and 3060mm lengths

N5-070 Step Edge Contrast 64mm

Available in standard lengths from 800mm to 1500mm in 100mm increments

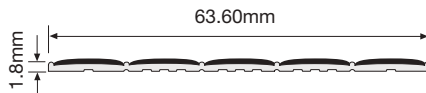

- Adhesive and caulking gun available separately
- Custom cutting is available from 2450mm and 3060mm lengths

N5-070 Polyurethane adhesive fixing
N5-070P Punched for screw fixing

For compliance information see product data sheets (downloadable from website)

Anti-Slip Products

Note: The following products are not Emergency Visibility products as they contain no PL but are suitable for use on step-edges to help prevent slips and falls in all weather conditions.

F9-180 Step Nosing 50mm x 25mm

Available in standard lengths from 800mm to 1500mm in 100mm increments

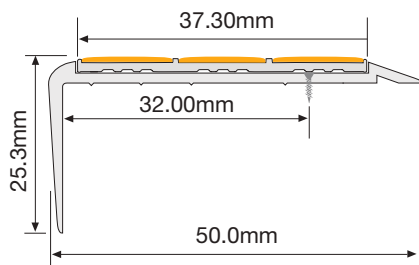
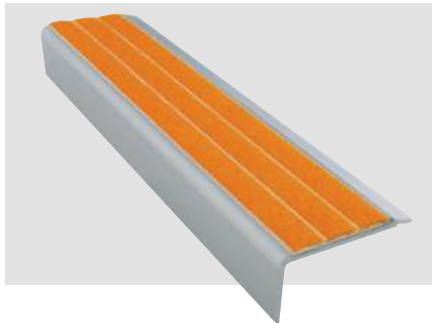

- Supplied pre-drilled with fixers.
- Adhesive and caulking gun available separately
- Custom cutting is available from 2450mm and 3060mm lengths

F14-180 Step Nosing 75mm x 10mm

Available in standard lengths from 800mm to 1500mm in 100mm increments

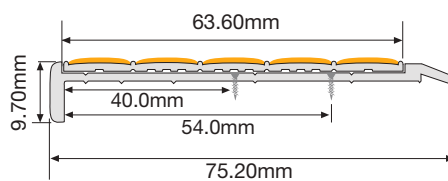
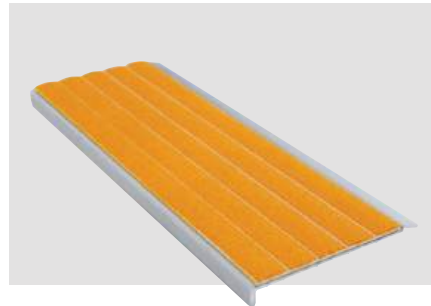

- Supplied pre-drilled with fixers.
- Adhesive and caulking gun available separately
- Custom cutting is available from 2450mm and 3060mm lengths

F15-180 Step Nosing 75mm x 33mm

Available in standard lengths from 800mm to 1500mm in 100mm increments

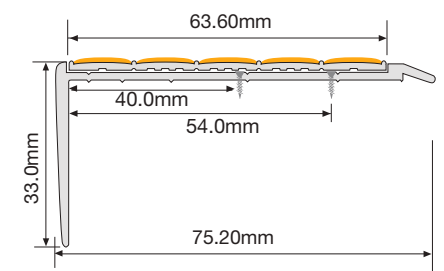
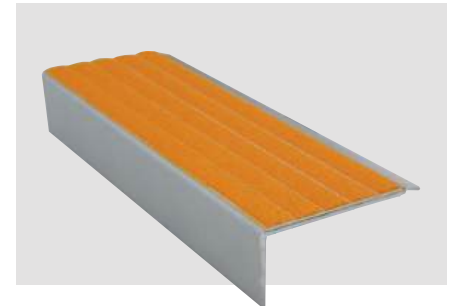

- Supplied pre-drilled with fixers.
- Adhesive and caulking gun available separately
- Custom cutting is available from 2450mm and 3060mm lengths

N2-080 Step Edge Contrast Anti/Slip 37mm

Available in standard lengths from 800mm to 1500mm in 100mm increments

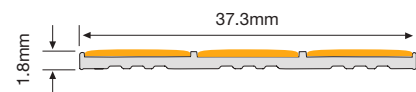
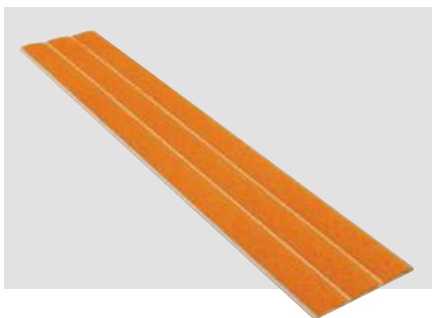

- Adhesive and caulking gun available separately
- Custom cutting is available from 2450mm and 3060mm lengths

N5-080 Step Edge Contrast 64mm

Available in standard lengths from 800mm to 1500mm in 100mm increments

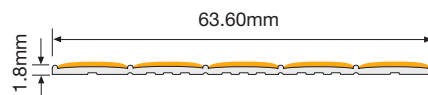
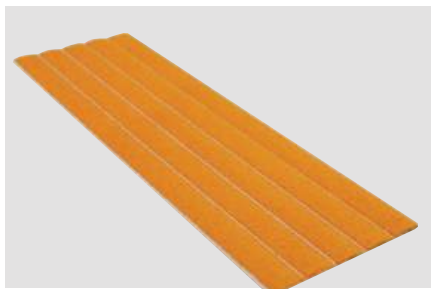

- Adhesive and caulking gun available separately
- Custom cutting is available from 2450mm and 3060mm lengths

N5-080 Polyurethane adhesive fixing
N5-080P Punched for screw fixing

For compliance information see product data sheets (downloadable from website)

Handrail Markers and Path Markers

H3-001 Handrail Marker 16mm

Available in 1000mm and 3060mm lengths

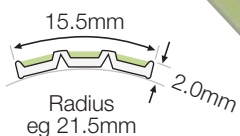

- H3-001-1000 Polyurethane adhesive fixing
- H3-001-3060 Polyurethane adhesive fixing
- H3-001T-1000 Release tape pre-fitted
- H3-001T-3060 Release tape pre-fitted

HREC3 Metal End Cap



END CAPS
Metal end cap
to fit H3-001

G6-003 Guidance Strip 26mm

Available in standard lengths from 800mm to 1500mm in 100mm increments

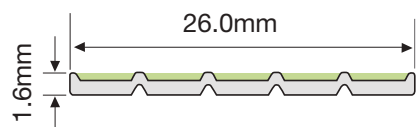

Custom cutting is available from 3060mm lengths

T2-103 Handrail Wall Marker 42mm

Available in 1000mm lengths

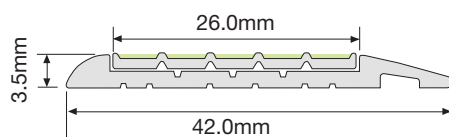
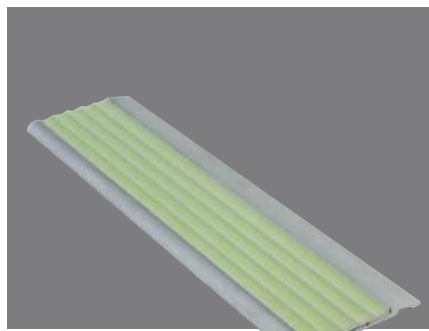

- T2-103-1000 Polyurethane adhesive fixing

G3-001 Guidance Strip 16mm

Available in 1000mm and 3060mm lengths

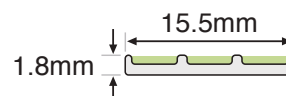

- G3-001-1000 Polyurethane adhesive fixing
- G3-001-3060 Polyurethane adhesive fixing
- G3-001P-1000 Punched for screw fixing
- G3-001P-3060 Punched for screw fixing
- G3-001T-1000 Release tape pre-fitted
- G3-001T-3060 Release tape pre-fitted

T6-101 Path Marker

Available in 1000mm lengths

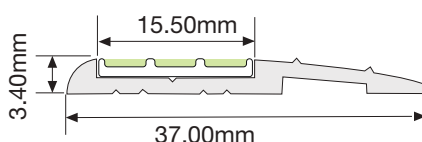
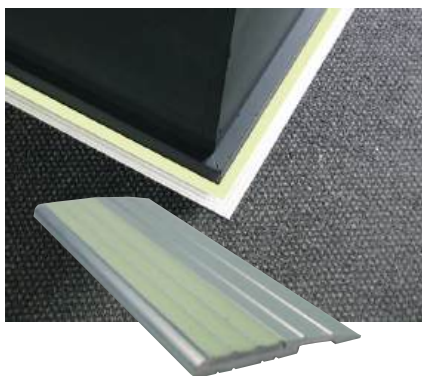

- T6-101-1000 Polyurethane adhesive fixing
- T6-101P-1000 Punched for screw fixing

T2-103 Path Marker 42mm

Available in 1000mm

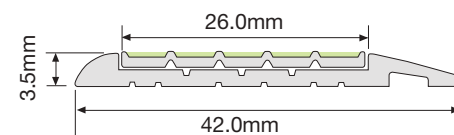
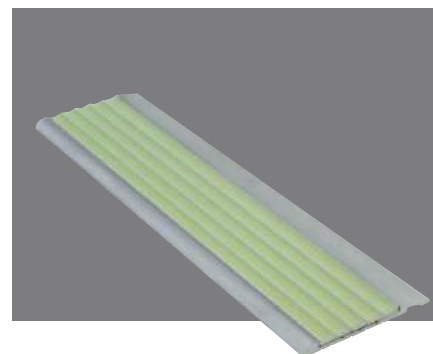

- T2-103-1000 Polyurethane adhesive fixing

For compliance information see product data sheets (downloadable from website)

UL 1994 PL Egress Signs

Floor Proximity Direction Signs. Suitable to meet RIRR 2019: SECTION 10.2.5.12 EXIT MARKING
Clause A (6) Directional Sign Requirements



Pictogram
Exit straight on from here
Product No. S5-RM2010
Size 200mm x 100mm

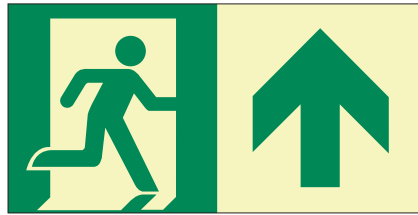

Pictogram Up Arrow
Exit straight on up from here
Product No. S5-RMUA2010
Size 200mm x 100mm



Pictogram Down Arrow
Exit down from here
Product No. S5-RMDA2010
Size 200mm x 100mm



Pictogram Up Left Arrow
Exit up left from here
Product No. S5-RMUL2010
Size 200mm x 100mm



Pictogram Down Left Arrow
Exit down left from here
Product No. S5-RMDL2010
Size 200mm x 100mm

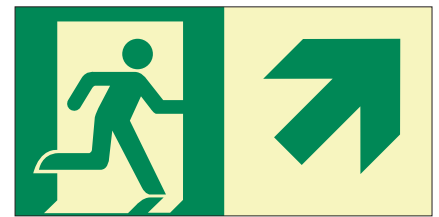

Pictogram Up Right Arrow
Exit up right from here
Product No. S5-RMUR2010
Size 200mm x 100mm

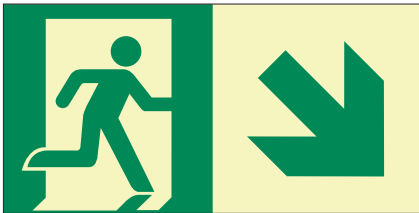

Pictogram Down Right Arrow
Exit down right from here
Product No. S5-RMDR2010
Size 200mm x 100mm



Pictogram Left Arrow
Exit left from here
Product No. S5-RML2010
Size 200mm x 100mm

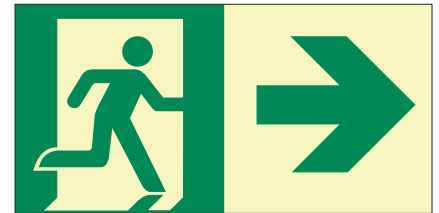

Pictogram Right Arrow
Exit right from here
Product No. S5-RMR2010
Size 200mm x 100mm

For compliance information see product data sheets (downloadable from website)

Miscellaneous Products

Stairway Identification Sign



Stairway Identification

Product No. S5-SI4631

Size 460mm x 310mm

**MADE
TO
ORDER**

Above graphics are an example only.
Each sign is custom printed.

Polyurethane Adhesive

890100182KD



Adhesive for Emergency Visibility Products



Caulking Gun

CLKGUN-600ml

To take 600ml Adhesive Sausage

Location ID Signs - Variable Data



Product No: S10-HN/HTC2010 Size 200mm x 100mm

Graphics are applied to the PL panel during the manufacturing process.
The sign also has HTC clear coating to protect the print in outdoor environments.

**MADE
TO
ORDER**

Above graphics are an example only.
Each sign is custom printed.

For compliance information see product data sheets (downloadable from website)



Exit Signs

S20 Exit Signs

To meet Fire Code of The Philippines
Section 10.2.5.12 Exit Marking

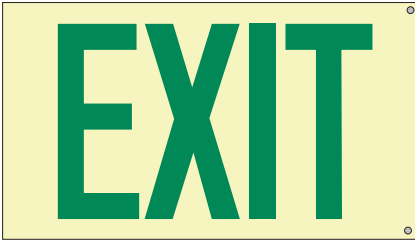

Exit

Exit straight on from here
Maximum Viewing Distance: 16m
Product No: S20-BFP2916-16m
Size 290mm x 162mm
Maximum Viewing Distance: 24m
Product No: S20-BFP4223-24m
Size 420mm x 230mm

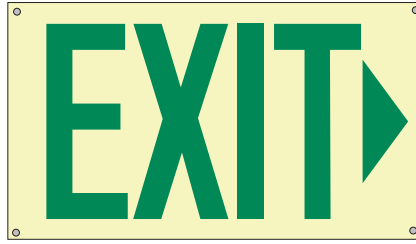

Exit Right

Exit right from here
Maximum Viewing Distance: 16m
Product No: S20-BFP2916R-16m
Size 290mm x 162mm
Maximum Viewing Distance: 24m
Product No: S20-BFP4223R-24m
Size 420mm x 230mm



Exit Left

Exit left from here
Maximum Viewing Distance: 16m
Product No: S20-BFP2916L-16m
Size 290mm x 162mm
Maximum Viewing Distance: 24m
Product No: S20-BFP4223L-24m
Size 420mm x 230mm



Exit Right and Left

Travel right and left
Maximum Viewing Distance: 16m
Product No: S20-BFP3416RL-16m
Size 340mm x 162mm
Maximum Viewing Distance: 24m
Product No: S20-BFP4923R-24m
Size 490mm x 230mm

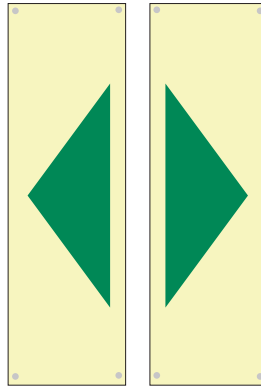

Chevron

Travel in this direction
Maximum Viewing Distance: 16m
Product No: S20-BFP162-16m
Size 50mm x 162mm
Maximum Viewing Distance: 24m
Product No: S20-BFP230-24m
Size 70mm x 230mm

For compliance information see product data sheets (downloadable from on website)

Hybrid LED Exit Signs

The Hybrid LED Exit Sign combines Ecoglo's internationally recognised photoluminescent technology with Class II LEDs and the next generation patented electronics. Requiring no backup, the internally illuminated photoluminescent exit sign is effective in all lighting scenarios.

Non-HTC product



Can be surface, ceiling or flag mounted



Sign can also be recessed into ceiling

The Hybrid LED exit sign is available single sided or double sided with a range of mounting options to satisfy architectural requirements.

Single sided sign (HYU1.2) or Double sided sign (HYU2.2)

(Wall and ceiling mounting options included with sign)

Signs include one or more of graphics shown below. Custom graphics can also be produced to suit regional requirements.

EX Exit straight on from here	EXL Exit left from here	EXR Exit right from here

24 metres viewing distance
These EXIT graphics are designed to meet RRIR 2019: Section 10.2.5.12



RM
Exit straight on from here



RML
Exit left from here



RMR
Exit right from here



RM DOUBLE ARROW
Exit right or left from here

CEILING AND WALL MOUNT

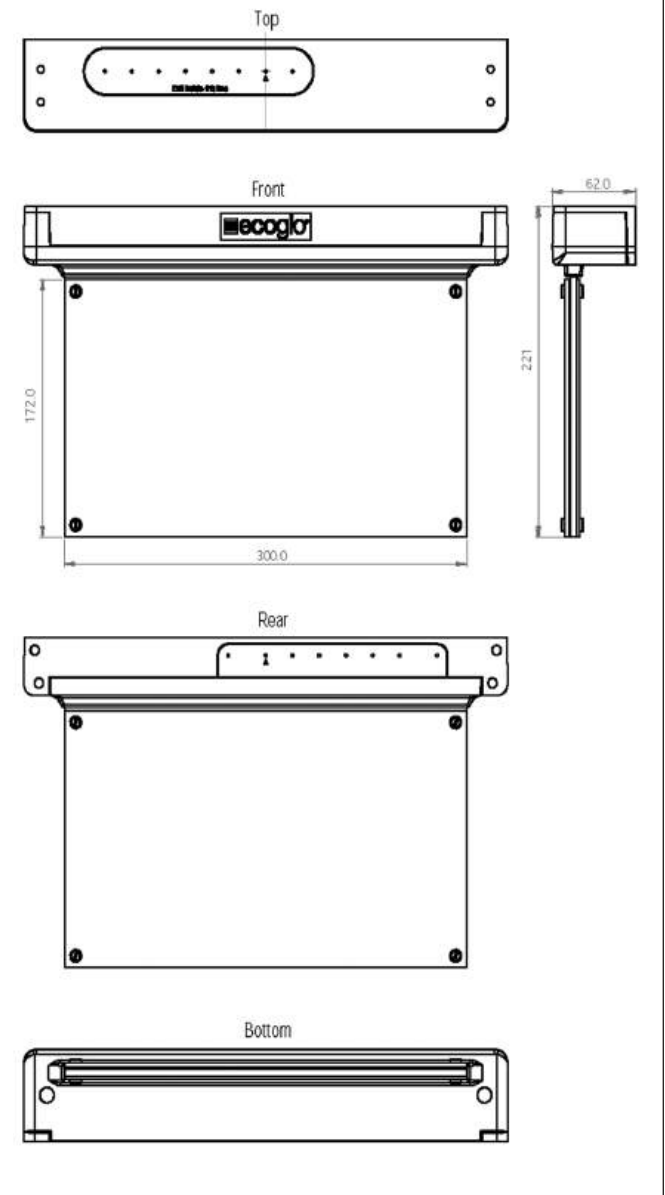

PRODUCT CODE	PRODUCT DESCRIPTION	GRAPHICS INCLUDED	MAXIMUM VIEWING DISTANCE
HYU1.2-BFP	Single Sided Hybrid Sign	1 x EX, 1 x EXR, 1 x EXL	24 metres
HYU1.2	Single Sided Hybrid Sign	1 x RM, 1 x RMR, 1 x RML	16 metres
HYU1.2-RMRL	Single Sided Hybrid Sign	1 x RM Double Arrow	16 metres
HYU2.2-BFP	Double Sided Hybrid Sign	2 x EX, 1 x EXR, 1 x EXL	24 metres
HYU2.2	Double Sided Hybrid Sign	2 x RM, 1 x RMR, 1 x RML	16 metres
HYU2.2-RMRL	Double Sided Hybrid Sign	2 x RM Double Arrow	16 metres

For compliance information see product data sheets (downloadable from website)

Hybrid LED Exit Signs Mounting Options

Flag mount bracket kit



BR3-FM.WHT White flag mount bracket kit
BR3-FM.BLK Black flag mount bracket kit

Ceiling recess bracket kit



BR3-CR.WHT White ceiling recess bracket kit
BR3-CR.BLK Black ceiling recess bracket kit

Wall and ceiling mounting options are included with hybrid signs, above options are sold separately.

Weatherproof exit enclosure



BR3-EXHS.WHT White Weatherproof Exit Enclosure

UL 924 PL Exit Signs

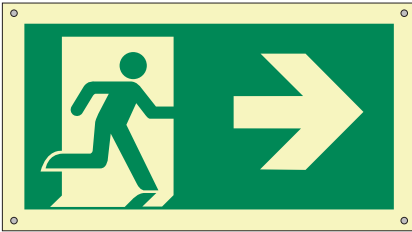

Pictogram Right Arrow

Exit right from here

Maximum Viewing Distance: 50 feet

Product No: S20-UL-RMR392223-50

Size 392mm x 223mm

Maximum Viewing Distance: 75 feet

Product No: S20-UL-RMR480280-75

Size 480mm x 280mm

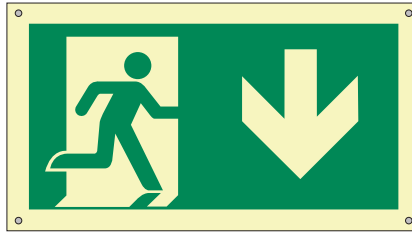

Pictogram Down Arrow

Exit down from here

Maximum Viewing Distance: 50 feet

Product No: S20-UL-RMDA392223-50

Size 392mm x 223mm

Maximum Viewing Distance: 75 feet

Product No: S20-UL-RMDA480280-75

Size 480mm x 280mm

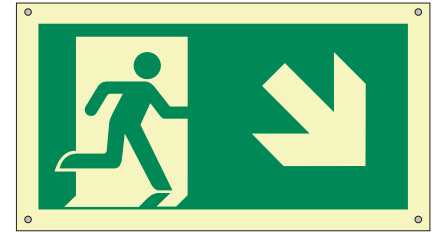

Pictogram Down Right Arrow

Exit down right from here

Maximum Viewing Distance: 50 feet

Product No: S20-UL-RMDR392223-50

Size 392mm x 223mm

Maximum Viewing Distance: 75 feet

Product No: S20-UL-RMDR480280-75

Size 480mm x 280mm



Pictogram Left Arrow

Exit left from here

Maximum Viewing Distance: 50 feet

Product No: S20-UL-RML392223-50

Size 392mm x 223mm

Maximum Viewing Distance: 75 feet

Product No: S20-UL-RML480280-75

Size 480mm x 280mm

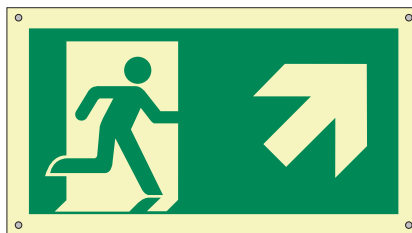

Pictogram Up Right Arrow

Exit up right from here

Maximum Viewing Distance: 50 feet

Product No: S20-UL-RMUR392223-50

Size 392mm x 223mm

Maximum Viewing Distance: 75 feet

Product No: S20-UL-RMUR480280-75

Size 480mm x 280mm

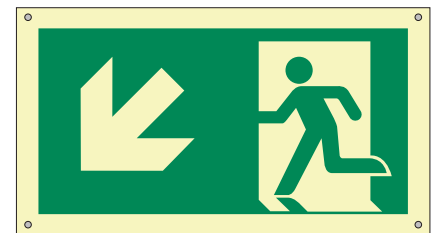

Pictogram Down Left Arrow

Exit down left from here

Maximum Viewing Distance: 50 feet

Product No: S20-UL-RMDL392223-50

Size 392mm x 223mm

Maximum Viewing Distance: 75 feet

Product No: S20-UL-RMDL480280-75

Size 480mm x 280mm

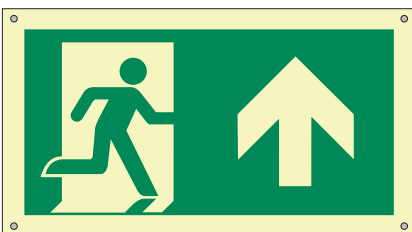

Pictogram Up Arrow

Exit straight on from here

Maximum Viewing Distance: 50 feet

Product No: S20-UL-RMUA392223-50

Size 392mm x 223mm

Maximum Viewing Distance: 75 feet

Product No: S20-UL-RMUA480280-75

Size 480mm x 280mm

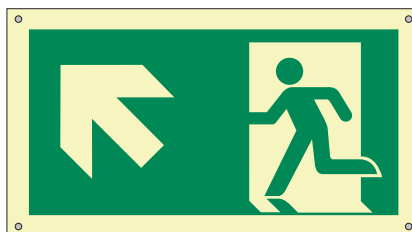

Pictogram Up Left Arrow

Exit up left from here

Maximum Viewing Distance: 50 feet

Product No: S20-UL-RMUL392223-50

Size 392mm x 223mm

Maximum Viewing Distance: 75 feet

Product No: S20-UL-RMUL480280-75

Size 480mm x 280mm



Exit

Exit straight on from here

Maximum Viewing Distance: 50 feet

Product No: S20-UL-EX353183-50

Size 353mm x 183mm

Maximum Viewing Distance: 75 feet

Product No: S20-UL-EX481249-75

Size 481mm x 249mm

UL 924 PL Exit Signs



Exit Left

Exit left from here

Maximum Viewing Distance: 50 feet
Product No: S20-UL-EXL353183-50
Size 353mm x 183mm

Maximum Viewing Distance: 75 feet
Product No: S20-UL-EXL481249-75
Size 481mm x 249mm



Exit Right

Exit right from here

Maximum Viewing Distance: 50 feet
Product No: S20-UL-EXR353183-50
Size 353mm x 183mm

Maximum Viewing Distance: 75 feet
Product No: S20-UL-EXR481249-75
Size 481mm x 249mm

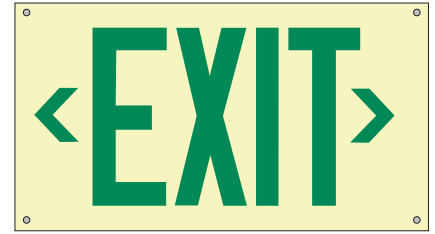

Exit Double Arrow

Exit straight on from here

Maximum Viewing Distance: 50 feet
Product No: S20-UL-EXRL353183-50
Size 353mm x 183mm

Maximum Viewing Distance: 75 feet
Product No: S20-UL-EXRL481249-75
Size 481mm x 249mm

Mounting / Hanging Options

Standard Mounting Brackets



CEILING MOUNT



FLAG MOUNT

Chain Suspension for Signs

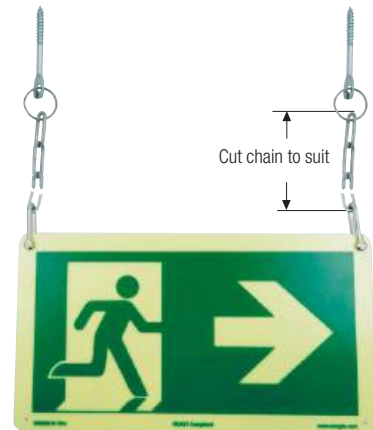

All UL924 and S20 signs include fixers for mounting the sign flat against a wall or other surface. Mounting brackets and chain suspension is also available (sold separately).

Contact infoPHL@ecoglo.com for more information



Fire Protection Signs

Emergency Evacuation Plans

Evacuation Plans are available on two types of photoluminescent material as below

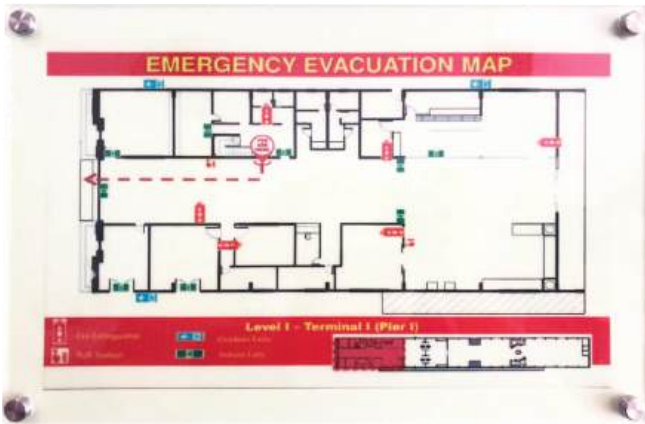

An example of an Evacuation Plan in normal light

HTC Evacuation Plan

Evacuation Plan (Aluminium Sheet)

Emergency Evacuation Plan
Product No. S5-EVAC216330
Size 216mm x 330mm

Product No. S5-EVAC457610
Size 457mm x 610mm

Product No. S5-EVAC610914
Size 610mm x 914mm

**MADE
TO
ORDER**



An example of an Evacuation Plan in darkness

Rigid PVC Evacuation Plan

Evacuation Plan (Rigid PVC with acrylic overlay)*

Emergency Evacuation Plan
Product No. G20-EVAC216330
Size 216mm x 330mm

Product No. G20-EVAC457610
Size 457mm x 610mm

Product No. G20-EVAC610914
Size 610mm x 914mm

* Non-HTC product

**MADE
TO
ORDER**

Above graphics are examples only, each sign is custom printed.

For compliance information see product data sheets (downloadable from website)

Fire Safety Signs



Fire Extinguisher
 Fire extinguisher located here
 Product No. S5-FEXT2010
 Size 200mm x 100mm
 Double sided unit Product No:
 BR5-DS-S5-FEXT2010



Fire Hose
 Fire hose located here
 Product No. S5-FH2010
 Size 200mm x 100mm
 Double sided unit Product No:
 BR5-DS-S5-FH2010



Fire Alarm
 Fire alarm located here
 Product No. S5-FA2010
 Size 200mm x 100mm
 Double sided unit Product No:
 BR5-DS-S5-FA2010

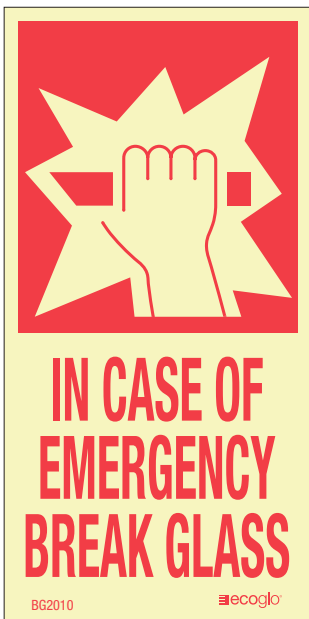

Break Glass
 In case of emergency break glass
 Product No. S5-BG2010
 Size 200mm x 100mm
 Double sided unit Product No:
 BR5-DS-S5-BG2010



All signs on this page are available as a single sign or as a double sided unit as seen above.
 The unit consists of two signs (each 200mm x 100mm) on a triangular mount.

For compliance information see product data sheets (downloadable from website)

S5 Directional Exit Signs

Text size to meet Fire Code of The Philippines
Section 10.2.5.12 clause C

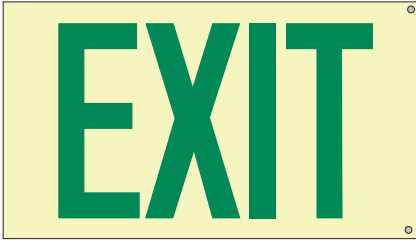

Exit

Exit straight on from here

Maximum Viewing Distance: 16m

Product No: S5-BFP2916-16m

Size 290mm x 162mm

Maximum Viewing Distance: 24m

Product No: S5-BFP4223-24m

Size 420mm x 230mm

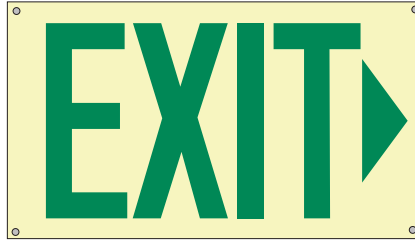

Exit Right

Exit right from here

Maximum Viewing Distance: 16m

Product No: S5-BFP2916R-16m

Size 290mm x 162mm

Maximum Viewing Distance: 24m

Product No: S5-BFP4223R-24m

Size 420mm x 230mm



Exit Left

Exit left from here

Maximum Viewing Distance: 16m

Product No: S5-BFP2916L-16m

Size 290mm x 162mm

Maximum Viewing Distance: 24m

Product No: S5-BFP4223L-24m

Size 420mm x 230mm



Exit Right and Left

Travel right and left

Maximum Viewing Distance: 16m

Product No: S5-BFP3416RL-16m

Size 340mm x 162mm

Maximum Viewing Distance: 24m

Product No: S5-BFP4923R-24m

Size 490mm x 230mm

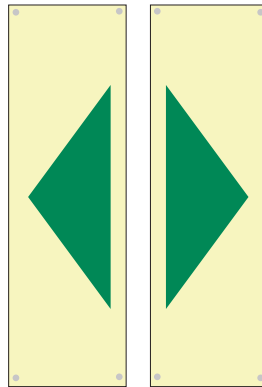

Chevron

Travel in this direction

Maximum Viewing Distance: 16m

Product No: S5-BFP162-16m

Size 50mm x 162mm

Maximum Viewing Distance: 24m

Product No: S5-BFP230-24m

Size 70mm x 230mm

For compliance information see product data sheets (downloadable from on website)



Disaster Preparedness Signs

S20 Disaster Preparedness Signs

MADE
TO
ORDER

Ecoglo manufactures Disaster Preparedness signs with three different types of graphics. All graphics are applied to Ecoglo S20 photoluminescent (PL) panels, but the method of application differs as below.

1. HTC - Graphics are applied to the panel during Ecoglo's manufacturing process, a process known as High Temperature Curing or HTC. This sign also has HTC clear coating added to protect the print in outdoor environments.

Graphics Warranty - 15 years outdoors

2. 3MR - Graphics consisting of high quality reflective vinyl are applied to the PL panel.

Graphics Warranty - 10 years outdoors

3. 3MS - Graphics consisting of high quality vinyl are applied to the PL panel.

Graphics Warranty - 6 years outdoors



Example above shows sign after reflective vinyl graphics have been applied to the PL panel.

Signs are available in three sizes as shown here.

See the full range of graphics with product codes on the next page.



315mm x 290mm



600mm x 475mm



945mm x 580mm

For compliance information see product data sheets (downloadable from website)

Disaster Preparedness Signs

MADE
TO
ORDER

TSUNAMI EVACUATE

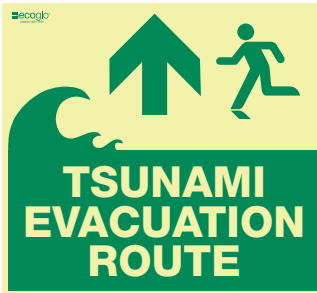

Product S20-EA315290-HTC
Codes S20-EA600475-HTC
S20-EA945580-HTC
S20-TE315290-3MR
S20-TE600475-3MR
S20-TE945580-3MR
S20-TE315290-3MS
S20-TE600475-3MS
S20-TE945580-3MS

EVACUATION AREA



Product S20-EA315290-HTC
Codes S20-EA600475-HTC
S20-EA945580-HTC
S20-EA315290-3MR
S20-EA600475-3MR
S20-EA945580-3MR
S20-EA315290-3MS
S20-EA600475-3MS
S20-EA945580-3MS

SEVERE WEATHER SHELTER



Product S20-SWS315290-HTC
Codes S20-SWS600475-HTC
S20-SWS945580-HTC
S20-SWS315290-3MR
S20-SWS600475-3MR
S20-SWS945580-3MR
S20-SWS315290-3MS
S20-SWS600475-3MS
S20-SWS945580-3MS

TSUNAMI EVACUATE RIGHT

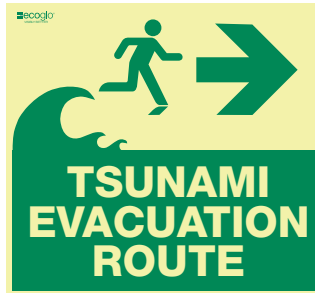

Product S20-TER315290-HTC
Codes S20-TER600475-HTC
S20-TER945580-HTC
S20-TER315290-3MR
S20-TER600475-3MR
S20-TER945580-3MR
S20-TER315290-3MS
S20-TER600475-3MS
S20-TER945580-3MS

EVACUATION AREA RIGHT



Product S20-EAR315290-HTC
Codes S20-EAR600475-HTC
S20-EAR945580-HTC
S20-EAR315290-3MR
S20-EAR600475-3MR
S20-EAR945580-3MR
S20-EAR315290-3MS
S20-EAR600475-3MS
S20-EAR945580-3MS

EVACUATION CENTER



Product S20-EC315290-HTC
Codes S20-EC600475-HTC
S20-EC945580-HTC
S20-EC315290-3MR
S20-EC600475-3MR
S20-EC945580-3MR
S20-EC315290-3MS
S20-EC600475-3MS
S20-EC945580-3MS

TSUNAMI EVACUATE LEFT

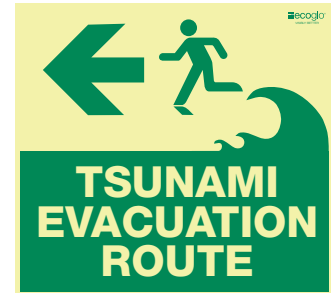

Product S20-TEL315290-HTC
Codes S20-TEL600475-HTC
S20-TEL945580-HTC
S20-TEL315290-3MR
S20-TEL600475-3MR
S20-TEL945580-3MR
S20-TEL315290-3MS
S20-TEL600475-3MS
S20-TEL945580-3MS

EVACUATION AREA LEFT



Product S20-EAL315290-HTC
Codes S20-EAL600475-HTC
S20-EAL945580-HTC
S20-EAL315290-3MR
S20-EAL600475-3MR
S20-EAL945580-3MR
S20-EAL315290-3MS
S20-EAL600475-3MS
S20-EAL945580-3MS

For compliance information see
product data sheets (downloadable
from website)

Disaster Preparedness Signs

MADE TO ORDER

FLOOD HAZARD ZONE



Product S20-FHZ315290-HTC
 Codes S20-FHZ600475-HTC
 S20-FHZ945580-HTC
 S20-FHZ315290-3MR
 S20-FHZ600475-3MR
 S20-FHZ945580-3MR
 S20-FHZ315290-3MS
 S20-FHZ600475-3MS
 S20-FHZ945580-3MS

Tsunami Hazard Zone



Product S20-THZ315290-HTC
 Codes S20-THZ600475-HTC
 S20-THZ945580-HTC
 S20-THZ315290-3MR
 S20-THZ600475-3MR
 S20-THZ945580-3MR
 S20-THZ315290-3MS
 S20-THZ600475-3MS
 S20-THZ945580-3MS

LANDSLIDE



Product S20-LS315290-HTC
 Codes S20-LS600475-HTC
 S20-LS945580-HTC
 S20-LS315290-3MR
 S20-LS600475-3MR
 S20-LS945580-3MR
 S20-LS315290-3MS
 S20-LS600475-3MS
 S20-LS945580-3MS

Earthquake Hazard Zone



Product S20-EHZ315290-HTC
 Codes S20-EHZ600475-HTC
 S20-EHZ945580-HTC
 S20-EHZ315290-3MR
 S20-EHZ600475-3MR
 S20-EHZ945580-3MR
 S20-EHZ315290-3MS
 S20-EHZ600475-3MS
 S20-EHZ945580-3MS

VOLCANIC HAZARD ZONE



Product S20-VHZ315290-HTC
 Codes S20-VHZ600475-HTC
 S20-VHZ945580-HTC
 S20-VHZ315290-3MR
 S20-VHZ600475-3MR
 S20-VHZ945580-3MR
 S20-VHZ315290-3MS
 S20-VHZ600475-3MS
 S20-VHZ945580-3MS

Water Depth Gauge



Product No: S20-WDG (HTC only)
 Size 115mm x 1000mm

Note: Image is for illustration purposes only. Each Water Depth Gauge is custom printed to specific requirements for each location.

For compliance information see product data sheets (downloadable from website)

Ecoglo International Limited

Warranty for Photoluminescent Performance of HTC* Signs and Products

1. We warrant the photoluminescent performance of both Signs and Products, manufactured using our High Temperature Curing (HTC) process, for a period of:
thirty years from the date of installation for standard Signs and Products which are positioned **indoors**; and **fifteen** years from the date of installation for **outdoor** Signs (specially coated for outdoor conditions) and Products which are positioned **outdoors**.
2. This warranty assumes normal conditions of use and maintenance but does not cover normal wear and tear. This warranty does not cover deterioration due to abuse, mistreatment, natural disasters (e.g. fire, flood), exposure to harmful chemicals or environments or any other use or exposure not recommended in our product literature. In particular, this warranty is void in the following circumstances:
 - 2.1 The Signs and/or Products have been misused, neglected, damaged, abused or involved in an accident.
 - 2.2 The Signs and/or Products have been improperly operated, repaired or maintained.
 - 2.3 The Signs and/or Products have been modified.
 - 2.4 The Signs and/or Products have been used outside their stated specifications, capacity and operating parameters.
3. If you have a claim that, in our reasonable judgement, satisfies the terms of this warranty, we shall replace the defective Sign or Product (material only).
4. This is an express warranty. It is your sole and exclusive remedy. We disclaim any other express or implied warranties, including warranties of merchantability or fitness for purpose, to the maximum extent permitted by law. Under no circumstances shall we accept liability for any injury to persons, damage to property, loss of profits, loss of operations or other direct, indirect, special, incidental, or consequential losses, costs and damages whether incurred by you, your guests, licensees, invitees or other third parties. Our liability under any circumstance, whether in contract, tort or otherwise, shall not, in the aggregate, exceed the price that you paid for the Sign and/or Product.
5. Some countries do not allow certain disclaimers, limitations or exclusions in warranties. Therefore, the above disclaimers, limitations and exclusions may not apply to you. This warranty gives you specific legal rights. You may have other rights or remedies pursuant to the laws of your country. Nothing in this limited warranty should be construed as limiting or restricting any other right or remedy available to you, except as allowed by the law in your country.

*Manufactured using High Temperature Curing (HTC)



Ecoglo Fire Protection Product Trading

36 C Gloria St., Brgy. San Carlos, Binangonan Rizal 1940 Philippines

HTC (High Temperature Curing)

The patented manufacturing process used to make Ecoglo's products is known as High Temperature Curing or HTC.

HTC involves the precisely controlled application of a powder mix of customised photoluminescent pigments and customised carriers (referred to as Purpose Designed Polymer or PDP) onto an aluminium base.

The polymer mix and aluminium base pass through a bespoke oven to be baked at temperatures above 160°C. This high temperature curing process integrally bonds the polymer mix to the aluminium, eliminating the possibility of peeling, shrinkage or delamination. It also provides permanent protection of the photoluminescent pigments from degradation due to moisture or weathering.

These performance properties cannot be guaranteed for photoluminescent PVC products and tapes.

HTC products won't suffer from shrinkage, delamination or discolouring and are therefore more durable delivering higher and more reliable luminance.



The following Ecoglo product ranges are Certified HTC

- Step Edge Contrast
- Step Nosings
- Handrail Markers
- Guidance Strips
- Path Markers
- Directional Signs
- Stairway Identification Signs
- Fire Protection Signs*
- UL 924 Signs
- UL 1994 Exit Signs
- S20 Exit Signs
- Disaster Preparedness Signs
- House Number Sign

**Note G20 Evacuation Map is not HTC as it isn't aluminium*



Ecoglo Fire Protection Product Trading

Address: 36-C Gloria Street, Barangay San Carlos,
Binangonan Rizal 1940, Philippines

Customer Service Cell: +63 917 545 0090 (call / text / whatsapp / viber)

Operations & Administration Landline: +63 2 8802 4760

Email: infoPHL@ecoglo.com

Web: www.ecoglo.ph